













SEAMASTER

AQUA TERRA 150M OMEGA CO-AXIAL ANNUAL CALENDAR 43 MM

Steel on leather strap

Caliber
8601

231.13.43.22.02.003

-  Co-Axial escapement
-  Si14 silicon balance spring
-  Automatic
-  Chronometer
-  Annual calendar
-  Sapphire crystal
-  Anti-reflective treatment on both sides
-  Sapphire crystal case back
-  Screw-in crown
-  Water-Resistant to a relative pressure of 15 bar (150 metres/500 feet)



WATCH FUNCTIONS

The crown has 3 positions:

1. Normal position (wearing position): when the crown is positioned against the case, the crown ensures that the watch is water-resistant.

Occasional winding: if the watch has not been worn for 55 hours or more, wind it up with the crown in position 1.

2. Annual calendar: pull the crown out to position 2. Turn the crown forwards to change the date or backwards to change the month. Push the crown back to position 1.

Note: the day following 28 or 29 February (depending on whether it is a leap year), the date needs to be adjusted by one or two days (crown in position 2). Ideally, the date should be adjusted after setting the time. When correcting the date between midnight and 10 am, the effort required for the first jump is slightly greater than for the others.

NB: Do not exit correction mode until the displays (date and month) are centred in the aperture.

3. Time setting: hours – minutes – seconds. Pull the crown out to position 3, the seconds hand will stop. Turn the crown forwards or backwards. Synchronise the seconds by pushing the crown back to position 1 to coincide with a given time signal.

NB: when changing the date backwards in time setting mode, it is necessary to wind the hands back to 2 pm to ensure the date changes.

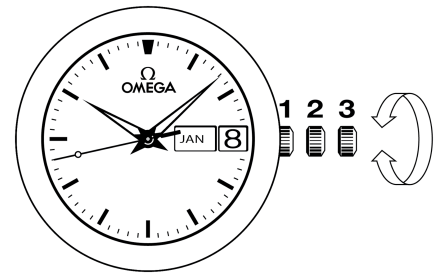

FOLDOVER CLASPS

Opening (fig. 1): to open the clasp, press the two pushers on either side of the OMEGA buckle and pull upwards.

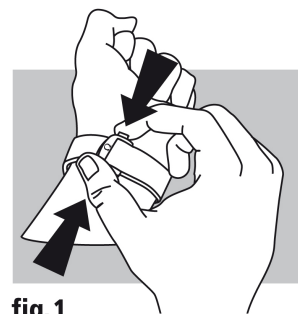

fig.1

Closing (fig. 2): put the watch on your wrist and close the clasp by pushing on it with your thumb until you hear a click. (fig. 2).

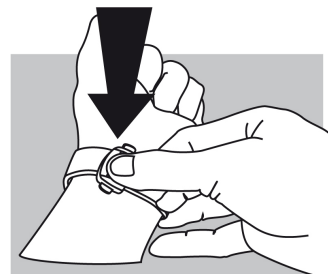

fig.2

Adjusting the length (fig. 3): free the longer section from the two slideways (A) and from the catch (B). Adjust the bracelet in the required direction and reinsert in the catch and the two slideways. Try the watch for size and readjust if necessary.

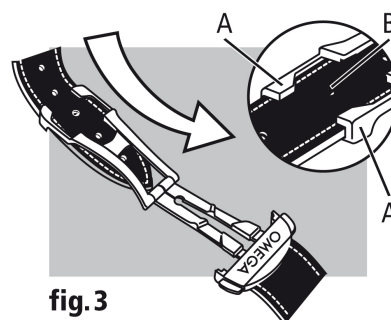

fig.3