















SEAMASTER

AQUA TERRA 150M OMEGA CO-AXIAL GMT CHRONOGRAPH 43 MM
Red gold on leather strap

Caliber
9615

231.53.43.52.06.001

-  Co-Axial escapement
-  Si14 silicon balance spring
-  Automatic
-  Chronometer
-  Time zone function
-  Second time zone
-  Sapphire crystal
-  Anti-reflective treatment on both sides
-  Sapphire crystal case back
-  Screw-in crown
-  Gold 750‰ (18K)
-  Water-Resistant to a relative pressure of 15 bar (150 metres/500 feet)



WATCH FUNCTIONS

The crown has 3 positions:

1. Normal position (wearing position): when the crown is positioned against the case, the crown ensures that the watch is water-resistant.

Occasional winding: if the watch has not been worn for 60 hours or more, wind it up with the crown in position 1.

2. Setting the time zone and correcting the date: pull the crown out to position 2. Turn the crown forwards or backwards, and only the hour hand will move forwards or backwards by 1-hour intervals. By passing the hour hand over midnight, the date can be changed forwards or backwards. Push the crown back to position 1.

Synchronisation of the hour hand and the '24-hour' hand

Pull the crown out to position 2 and turn it to synchronise the hour hand with the time indicated by the '24-hour' hand on the 24-hour scale in the centre of the dial. Make sure you set the hour hand in the correct half of the day!

After synchronising the hour hand with the '24-hour' hand, you must set the local time on your watch. Push the crown back to position 1.

3. Time setting: 24 hours - hours - minutes - seconds. Pull the crown out to position 3. The seconds hand will stop. Turn the crown forwards or backwards. Synchronise the seconds by pushing the crown back to position 1 to coincide with a given time signal.

SECOND TIME ZONE

Thanks to the '24-hour' hand with its triangular point, travellers can read the time back home at a glance on the 24-hour scale at the centre of the dial.

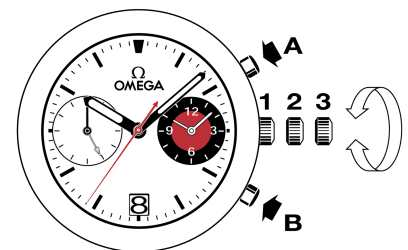

Timing to 1/8 of a second for up to 12 hours.

FOLDOVER CLASPS

Opening (fig. 1): to open the clasp, press the two pushers on either side of the OMEGA buckle and pull upwards.

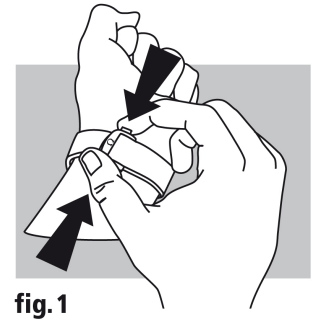

fig.1

Closing (fig. 2): put the watch on your wrist and close the clasp by pushing on it with your thumb until you hear a click. (fig. 2).

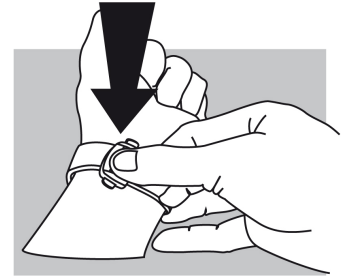

fig.2

Adjusting the length (fig. 3): free the longer section from the two slideways (A) and from the catch (B). Adjust the bracelet in the required direction and reinsert in the catch and the two slideways. Try the watch for size and readjust if necessary.

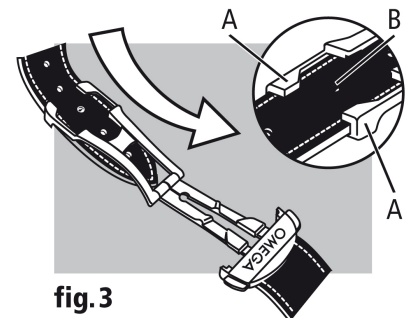

fig.3