













SPEEDMASTER

BROAD ARROW CO-AXIAL CHRONOGRAPH 42 MM

Steel - red gold on leather strap

Caliber
3313

321.93.42.50.13.001

-  Co-Axial escapement
-  Automatic
-  Chronometer
-  Tachymeter
-  Sapphire crystal
-  Anti-reflective treatment
-  Sapphire crystal case back
-  Gold 750‰ (18K)
-  3-year International Warranty
-  Water-Resistant to a relative pressure of 10 bar (100 metres/330 feet)



WATCH FUNCTIONS

The crown has 3 positions:

1. Normal position (wearing position): when the crown is positioned against the case, the crown ensures that the watch is water-resistant.

Occasional winding: if the watch has not been worn for 44 hours or more, wind it up with the crown in position 1.

2. Correcting the date: pull the crown out to position 2, turn the crown forwards, then push the crown back to position 1.

NB: the date cannot be corrected between 8:30 pm and 1 am.

3. Time setting: hours – minutes – seconds. Pull the crown out to position 3. The seconds hand will stop. Turn the crown forwards or backwards. Synchronise the seconds by pushing the crown back to position 1 to coincide with a given time signal.

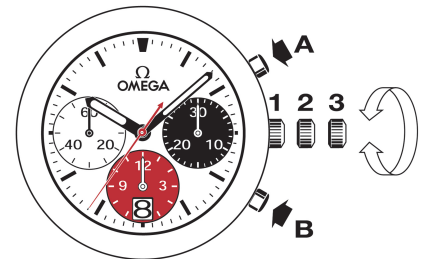

CHRONOGRAPH FUNCTIONS

• **Pusher A:** start – stop, start – stop, etc
Timing to 1/8 of a second for up to 12 hours.

• **Pusher B:** reset (after a stop).

Note: resetting/zeroing of the sub dials must only be carried out after the chronograph has stopped. Never push the chronograph's two pushers (A and B) simultaneously.

TACHYMETRIC SCALES

The desired information is read between the central seconds hand of the chronograph and the corresponding scale, over a maximum duration of 60 seconds.

Example: calculating the speed of a car.

Record the time the car takes to cover a distance of 1 kilometre. Read off the tachymetric scale the speed indicated by the central seconds hand. In this case, the car is travelling at 120 km/h.



FOLDOVER CLASPS

Opening (fig. 1): to open the clasp, press the two pushers on either side of the OMEGA buckle and pull upwards.

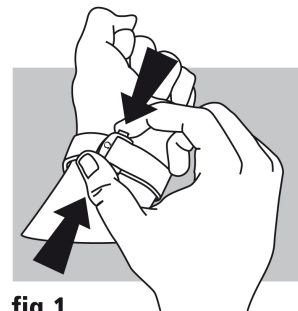

fig.1

Closing (fig. 2): put the watch on your wrist and close the clasp by pushing on it with your thumb until you hear a click. (fig. 2).

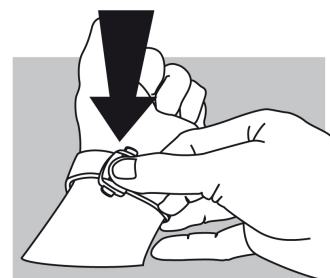

fig.2

Adjusting the length (fig. 3): free the longer section from the two slideways (A) and from the catch (B). Adjust the bracelet in the required direction and reinsert in the catch and the two slideways. Try the watch for size and readjust if necessary.

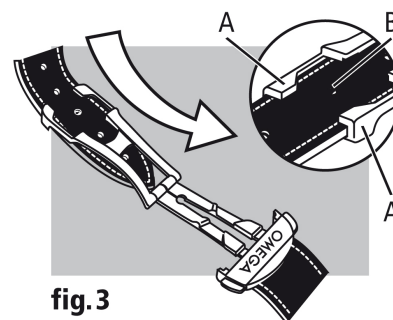

fig.3