













## SPEEDMASTER

BROAD ARROW CO-AXIAL GMT CHRONOGRAPH 44.25 MM

Steel on leather strap

Caliber  
**3603**

**3881.30.37**

-  Co-Axial escapement
-  Automatic
-  Chronometer
-  Time zone function
-  Second time zone
-  Tachymeter
-  Sapphire crystal
-  Anti-reflective treatment
-  Sapphire crystal case back
-  3-year International Warranty
-  Water-Resistant to a relative pressure of 10 bar (100 metres/330 feet)



## WATCH FUNCTIONS

The crown has 3 positions:

**1. Normal position (wearing position):** when the crown is positioned against the case, the crown ensures that the watch is water-resistant.

**Occasional winding:** if the watch has not been worn for 55 hours or more, wind it up with the crown in position 1.

**2. Setting the time zone and correcting the date:** pull the crown out to position 2. Turn the crown forwards or backwards, and the hour hand will move forwards or backwards by 1-hour intervals. By passing the hour hand over midnight, the date can be changed forwards or backwards. Push the crown back to position 1.

### Synchronisation of the hour hand and the '24-hour' hand

Pull the crown out to position 2 and turn it to synchronise the hour hand with the time indicated by the '24-hour' hand on the 24-hour scale in the centre of the dial. Make sure you set the hour hand in the correct half of the day!

After synchronising the hour hand with the '24-hour' hand, you must set the local time on your watch. Push the crown back to position 1.

**3. Time setting:** hours – minutes – seconds. Pull the crown out to position 3. The seconds hand will stop. Turn the crown forwards or backwards. Synchronise the seconds by pushing the crown back to position 1 to coincide with a given time signal.

## SECOND TIME ZONE

Thanks to the '24-hour' hand with its triangular point, travellers can read the time back home at a glance on the 24-hour scale.

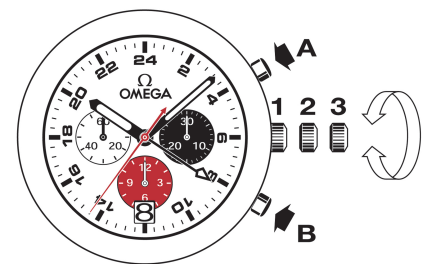

## CHRONOGRAPH FUNCTIONS

• **Pusher A:** start – stop, start – stop, etc  
Timing to 1/8 of a second for up to 12 hours.

• **Pusher B:** reset (after a stop).

*Note: resetting/zeroing of the sub dials must only be carried out after the chronograph has stopped. Never push the chronograph's two pushers (A and B) simultaneously.*

## TACHYMETRIC SCALES

The desired information is read between the central seconds hand of the chronograph and the corresponding scale, over a maximum duration of 60 seconds.

Example: calculating the speed of a car.

Record the time the car takes to cover a distance of 1 kilometre. Read off the tachymetric scale the speed indicated by the central seconds hand. In this case, the car is travelling at 120 km/h.

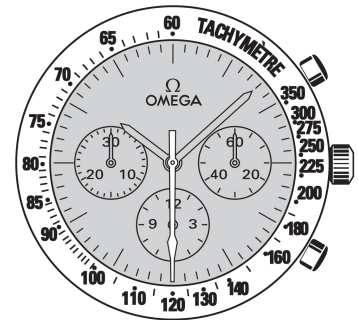

## FOLDOVER CLASPS

**Opening (fig. 1):** to open the clasp, press the two pushers on either side of the OMEGA buckle and pull upwards.

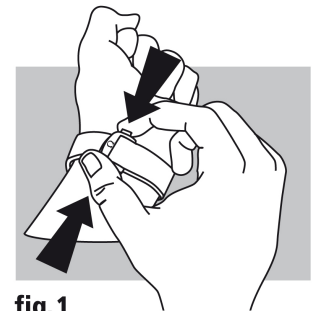

fig. 1

**Closing (fig. 2):** put the watch on your wrist and close the clasp by pushing on it with your thumb until you hear a click. (fig. 2).

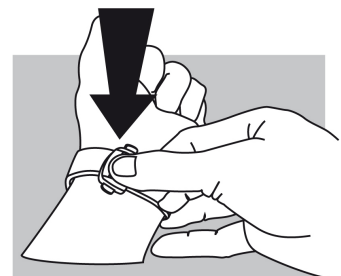

fig. 2

**Adjusting the length (fig. 3):** free the longer section from the two slideways (A) and from the catch (B). Adjust the bracelet in the required direction and reinsert in the catch and the two slideways. Try the watch for size and readjust if necessary.

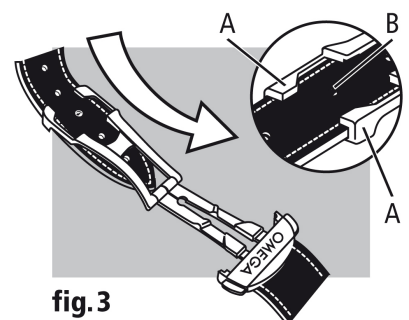

fig. 3