











DE VILLE

CHRONOSCOPE CO-AXIAL RATTRAPANTE

Steel on leather strap

Caliber
3612

4848.40.31

-  Co-Axial escapement
-  Automatic
-  Chronometer
-  Rattrapante
-  Sapphire crystal
-  Anti-reflective treatment on both sides
-  3-year International Warranty
-  Water-Resistant to a relative pressure of 10 bar (100 metres/330 feet)



WATCH FUNCTIONS

The crown has 3 positions:

1. Normal position (wearing position): when the crown is positioned against the case, the crown ensures that the watch is water-resistant.

Occasional winding: if the watch has not been worn for 55 hours or more, wind it up with the crown in position 1.

2. Correcting the date: pull the crown out to position 2, turn the crown backwards, then push the crown back to position 1.

NB: the date cannot be corrected between 9 pm and 12.30 am.

3. Time setting: hours – minutes – seconds. Pull the crown out to position 3. The seconds hand will stop. Turn the crown forwards or backwards. Synchronise the seconds by pushing the crown back to position 1 to coincide with a given time signal.

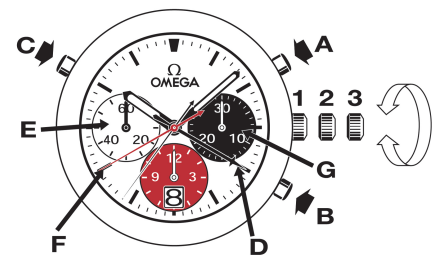

CHRONOGRAPH FUNCTIONS

• **Pusher A:** start – stop, start – stop, etc
Timing to 1/8 of a second for up to 12 hours.

• **Pusher B:** reset (after a stop).

Note: resetting/zeroing of the sub dials must only be carried out after the chronograph has stopped. Never push the chronograph's two pushers (A and B) simultaneously.

CHRONOGRAPH FUNCTIONS WITH SPLIT-SECONDS

The split-seconds function allows split times to be recorded whilst the chronograph is running.

1. Start the chronograph by pressing pusher (A) (start).
2. To record a split time, press pusher (C). The split-seconds hand (D) stops, indicating the split time, whilst the chronograph continues running.

NB: the split time should be read immediately, since the chronograph totalisers for hours (G), minutes (E) and seconds (F) continue to measure the elapsed time.

3. Press pusher (C) for the split-seconds hand to catch up with the chronograph seconds hand (F).
4. To record a new split time, start from step 2 above.
5. Press pusher (A) to stop the chronograph.
6. Press pusher (B) to reset.

NB: the split-seconds hand (D) must have caught up with the chronograph seconds hand (F) as explained in step 3 before the chronograph mechanism is reset/zeroed.

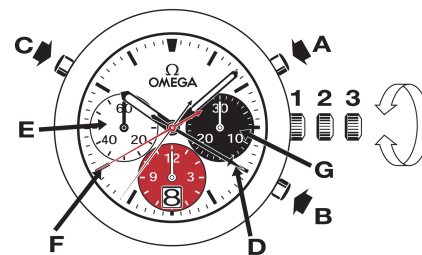

FOLDOVER CLASPS

Opening (fig. 1): to open the clasp, press the two pushers on either side of the OMEGA buckle and pull upwards.

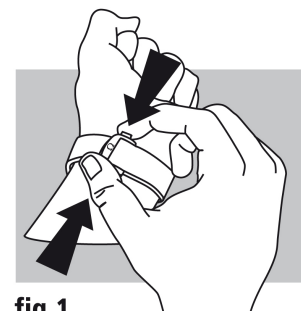

fig.1

Closing (fig. 2): put the watch on your wrist and close the clasp by pushing on it with your thumb until you hear a click. (fig. 2).

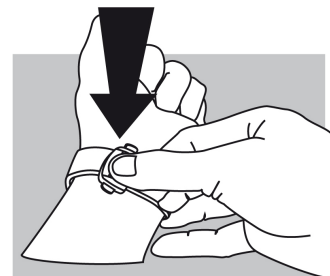

fig.2

Adjusting the length (fig. 3): free the longer section from the two slideways (A) and from the catch (B). Adjust the bracelet in the required direction and reinsert in the catch and the two slideways. Try the watch for size and readjust if necessary.

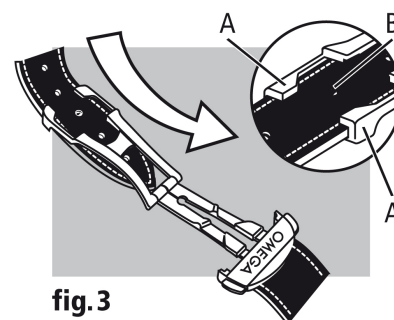

fig.3